

## Dual Buck chopper MOSFET Power Module

$V_{DSS} = 100V$   
 $R_{DSon} = 9m\Omega \text{ typ @ } T_j = 25^\circ C$   
 $I_D = 139A \text{ @ } T_c = 25^\circ C$

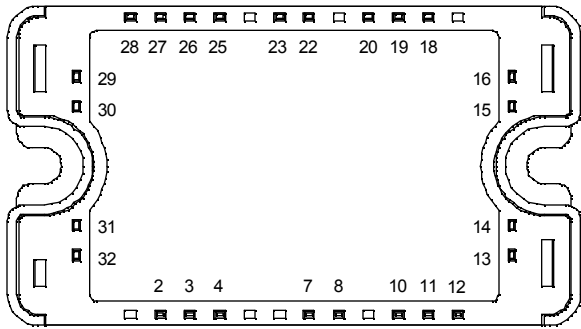
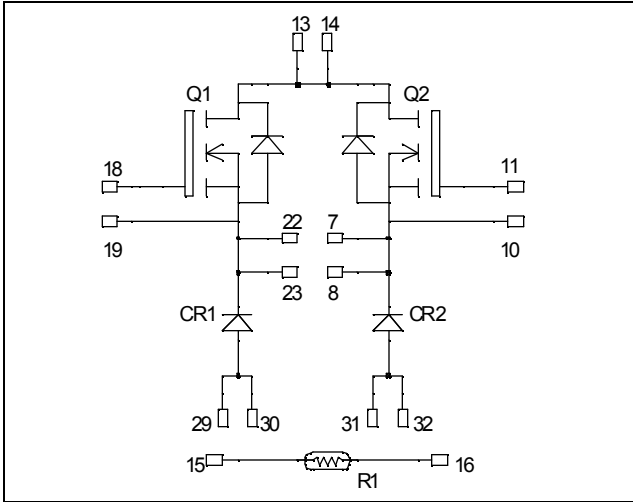

All multiple inputs and outputs must be shorted together  
 Example: 13/14 ; 29/30 ; 22/23 ...

### Application

- AC and DC motor control
- Switched Mode Power Supplies

### Features

- Power MOS V<sup>®</sup> MOSFETs
  - Low  $R_{DSon}$
  - Low input and Miller capacitance
  - Low gate charge
  - Avalanche energy rated
  - Very rugged
- Kelvin source for easy drive
- Very low stray inductance
  - Symmetrical design
- Internal thermistor for temperature monitoring
- High level of integration

### Benefits

- Outstanding performance at high frequency operation
- Direct mounting to heatsink (isolated package)
- Low junction to case thermal resistance
- Solderable terminals both for power and signal for easy PCB mounting
- Low profile
- Each leg can be easily paralleled to achieve a single buck of twice the current capability
- RoHS Compliant

### Absolute maximum ratings

Symbol	Parameter	Max ratings	Unit
$V_{DSS}$	Drain - Source Breakdown Voltage	100	V
$I_D$	Continuous Drain Current	$T_c = 25^\circ C$	139
		$T_c = 80^\circ C$	100 *
$I_{DM}$	Pulsed Drain current	430	A
$V_{GS}$	Gate - Source Voltage	$\pm 30$	V
$R_{DSon}$	Drain - Source ON Resistance	10	$m\Omega$
$P_D$	Maximum Power Dissipation	$T_c = 25^\circ C$	390
$I_{AR}$	Avalanche current (repetitive and non repetitive)	100	A
$E_{AR}$	Repetitive Avalanche Energy	50	mJ
$E_{AS}$	Single Pulse Avalanche Energy	3000	

\* Specification of MOSFET device but output current must be limited to 75A to not exceed a delta of temperature greater than 30°C for the connectors.

**CAUTION:** These Devices are sensitive to Electrostatic Discharge. Proper Handling Procedures Should Be Followed. See application note APT0502 on [www.microsemi.com](http://www.microsemi.com)

All ratings @  $T_j = 25^\circ\text{C}$  unless otherwise specified

**Electrical Characteristics**

Symbol	Characteristic	Test Conditions	Min	Typ	Max	Unit
$I_{DSS}$	Zero Gate Voltage Drain Current	$V_{GS} = 0V, V_{DS} = 100V$   $T_j = 25^\circ\text{C}$			100	$\mu\text{A}$
		$V_{GS} = 0V, V_{DS} = 80V$   $T_j = 125^\circ\text{C}$			500	
$R_{DS(on)}$	Drain – Source on Resistance	$V_{GS} = 10V, I_D = 69.5A$		9	10	$\text{m}\Omega$
$V_{GS(th)}$	Gate Threshold Voltage	$V_{GS} = V_{DS}, I_D = 2.5\text{mA}$	2		4	V
$I_{GSS}$	Gate – Source Leakage Current	$V_{GS} = \pm 30V, V_{DS} = 0V$			$\pm 100$	nA

**Dynamic Characteristics**

Symbol	Characteristic	Test Conditions	Min	Typ	Max	Unit
$C_{iss}$	Input Capacitance	$V_{GS} = 0V$ $V_{DS} = 25V$ $f = 1\text{MHz}$		9875		pF
$C_{oss}$	Output Capacitance			3940		
$C_{rss}$	Reverse Transfer Capacitance			1470		
$Q_g$	Total gate Charge	$V_{GS} = 10V$ $V_{Bus} = 50V$ $I_D = 139A$		350		nC
$Q_{gs}$	Gate – Source Charge			60		
$Q_{gd}$	Gate – Drain Charge			180		
$T_{d(on)}$	Turn-on Delay Time	<b>Inductive switching @ <math>125^\circ\text{C}</math></b> $V_{GS} = 15V$ $V_{Bus} = 66V$ $I_D = 139A$ $R_G = 5\Omega$		35		ns
$T_r$	Rise Time			70		
$T_{d(off)}$	Turn-off Delay Time			95		
$T_f$	Fall Time			125		
$E_{on}$	Turn-on Switching Energy	<b>Inductive switching @ <math>25^\circ\text{C}</math></b> $V_{GS} = 15V, V_{Bus} = 66V$ $I_D = 139A, R_G = 5\Omega$		552		$\mu\text{J}$
$E_{off}$	Turn-off Switching Energy			604		
$E_{on}$	Turn-on Switching Energy	<b>Inductive switching @ <math>125^\circ\text{C}</math></b> $V_{GS} = 15V, V_{Bus} = 66V$ $I_D = 139A, R_G = 5\Omega$		608		$\mu\text{J}$
$E_{off}$	Turn-off Switching Energy			641		

**Diode ratings and characteristics**

Symbol	Characteristic	Test Conditions	Min	Typ	Max	Unit
$V_{RRM}$	Maximum Peak Repetitive Reverse Voltage		200			V
$I_{RM}$	Maximum Reverse Leakage Current	$V_R = 200V$	$T_j = 25^\circ\text{C}$		250	$\mu\text{A}$
			$T_j = 125^\circ\text{C}$		500	
$I_F$	DC Forward Current	$T_c = 80^\circ\text{C}$		100		A
$V_F$	Diode Forward Voltage	$I_F = 100A$		1		V
		$I_F = 200A$		1.4		
		$I_F = 100A$   $T_j = 125^\circ\text{C}$		0.9		
$t_{rr}$	Reverse Recovery Time	$I_F = 100A$ $V_R = 133V$ $di/dt = 200A/\mu\text{s}$	$T_j = 25^\circ\text{C}$	60		ns
			$T_j = 125^\circ\text{C}$	110		
$Q_{rr}$	Reverse Recovery Charge	$I_F = 100A$ $V_R = 133V$ $di/dt = 200A/\mu\text{s}$	$T_j = 25^\circ\text{C}$	200		nC
			$T_j = 125^\circ\text{C}$	840		

**Thermal and package characteristics**
*Symbol Characteristic*

		<i>Min</i>	<i>Typ</i>	<i>Max</i>	<i>Unit</i>	
R <sub>thJC</sub>	Junction to Case Thermal Resistance	Transistor		0.32	°C/W	
		Diode		0.55		
V <sub>ISOL</sub>	RMS Isolation Voltage, any terminal to case t=1 min, I <sub>isol</sub> <1mA, 50/60Hz	2500			V	
T <sub>J</sub>	Operating junction temperature range	-40		150	°C	
T <sub>STG</sub>	Storage Temperature Range	-40		125		
T <sub>C</sub>	Operating Case Temperature	-40		100		
Torque	Mounting torque	To heatsink	M4	2.5	4.7	N.m
Wt	Package Weight				110	g

**Temperature sensor NTC** (see application note APT0406 on [www.microsemi.com](http://www.microsemi.com) for more information).

*Symbol Characteristic*

		<i>Min</i>	<i>Typ</i>	<i>Max</i>	<i>Unit</i>
R <sub>25</sub>	Resistance @ 25°C		50		kΩ
B <sub>25/85</sub>	T <sub>25</sub> = 298.15 K		3952		K

$$R_T = \frac{R_{25}}{\exp \left[ B_{25/85} \left( \frac{1}{T_{25}} - \frac{1}{T} \right) \right]}$$

T: Thermistor temperature  
 R<sub>T</sub>: Thermistor value at T

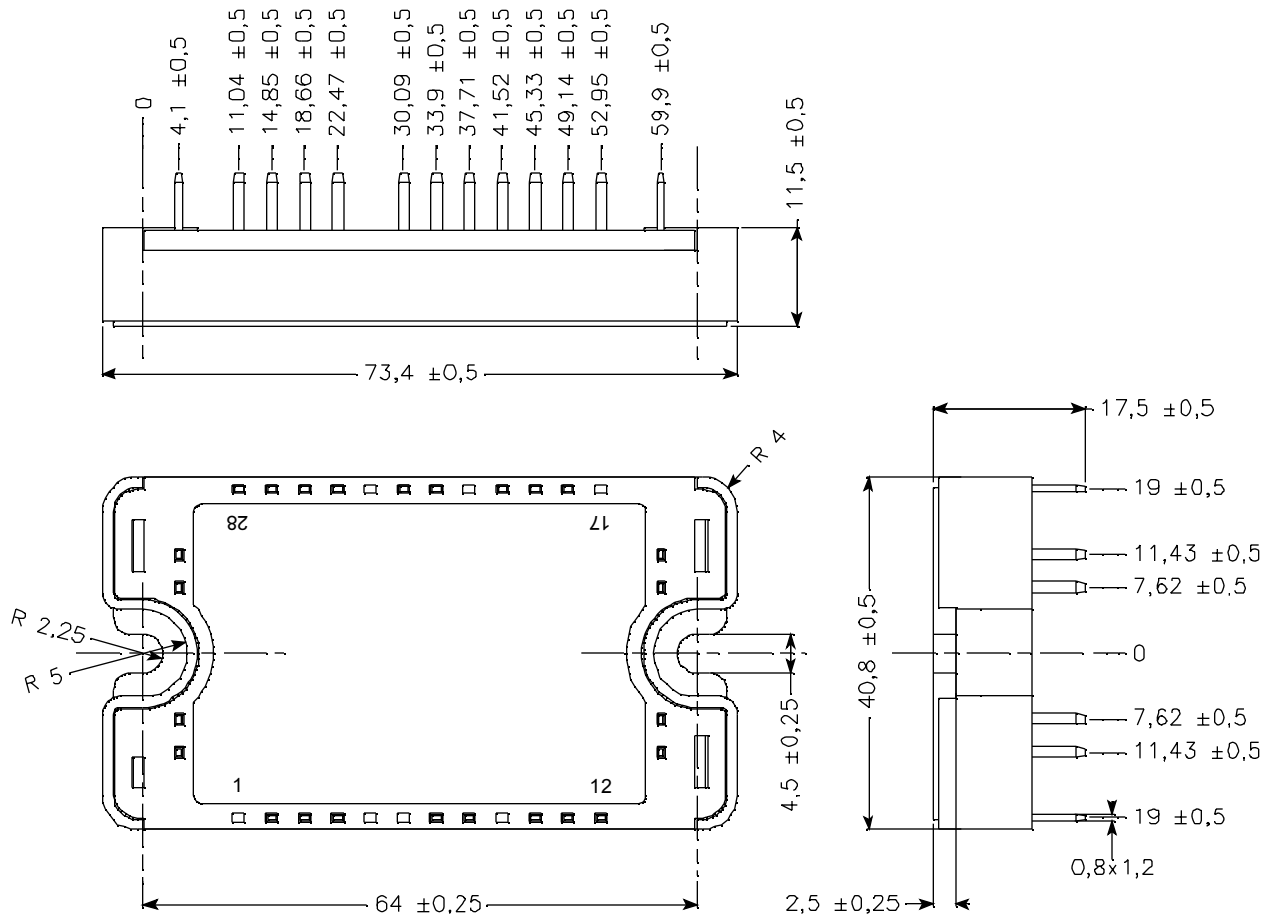
**SP3 Package outline** (dimensions in mm)

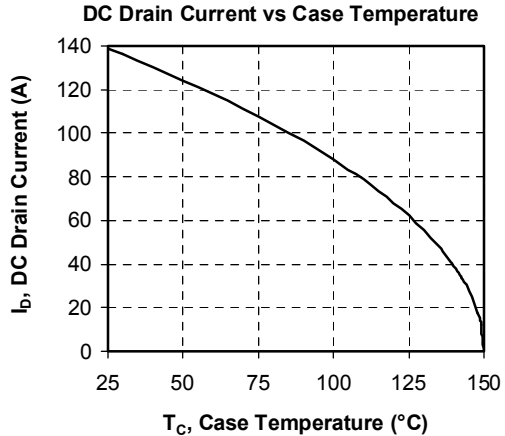
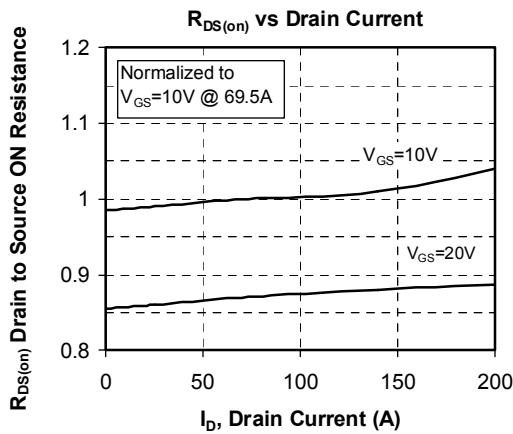
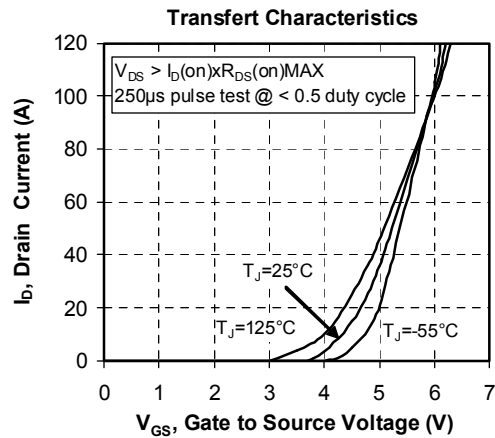
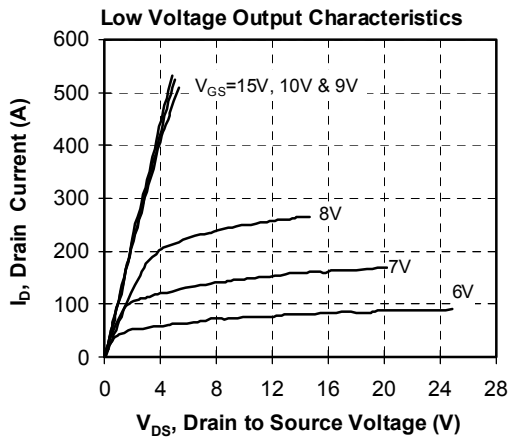
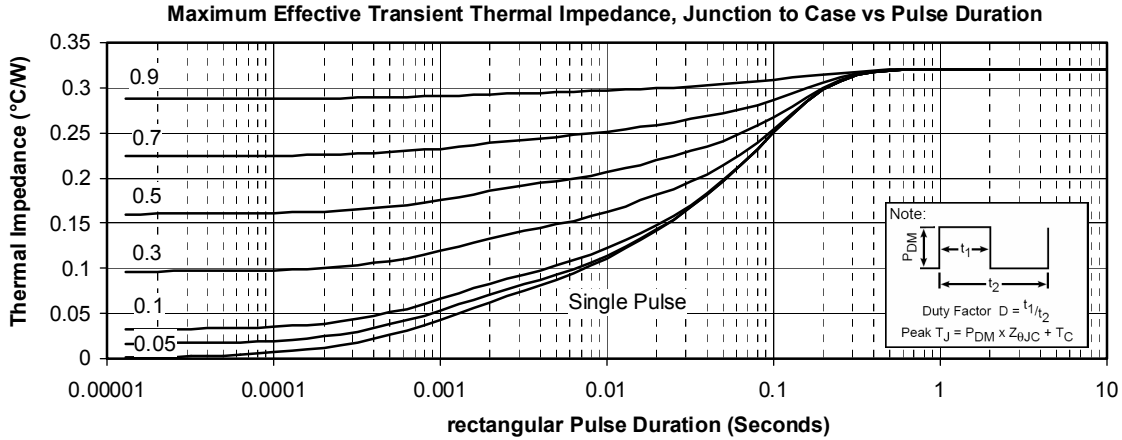
 See application note 1901 - Mounting Instructions for SP3 Power Modules on [www.microsemi.com](http://www.microsemi.com)

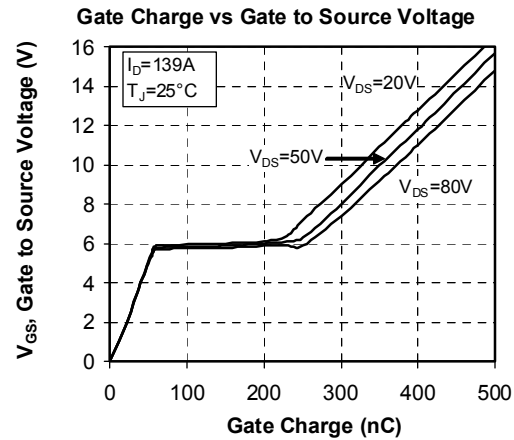
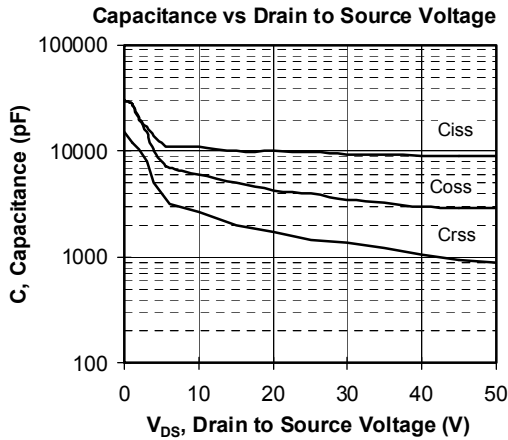
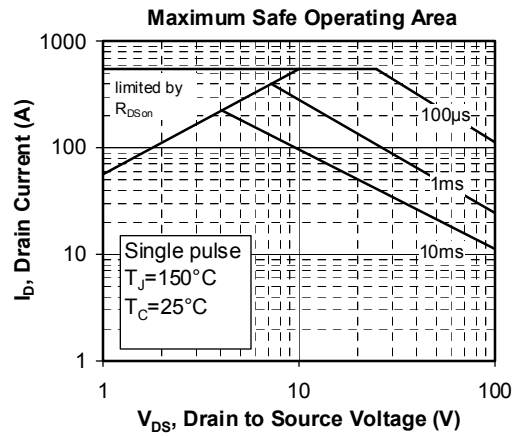
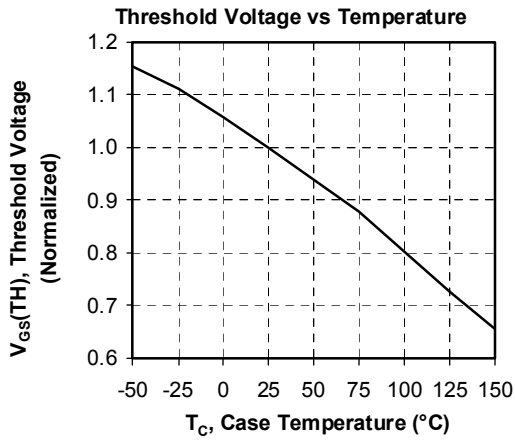
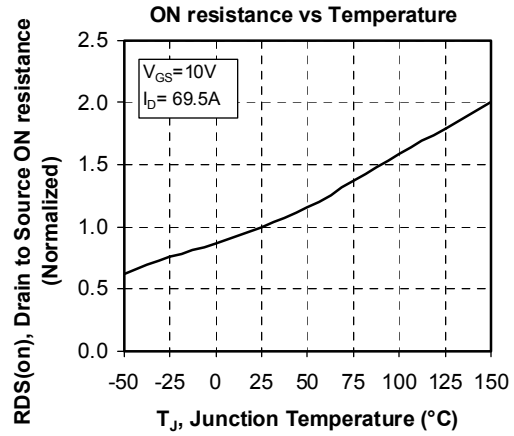
**Typical Performance Curve**

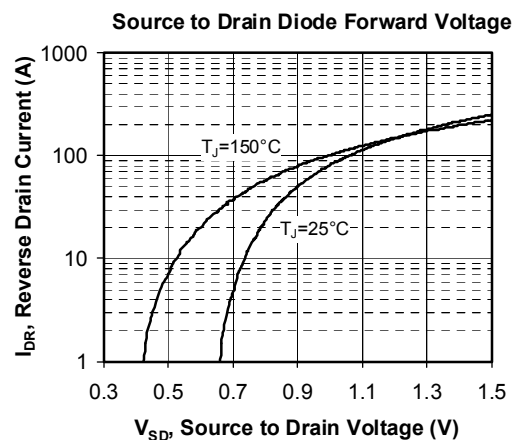
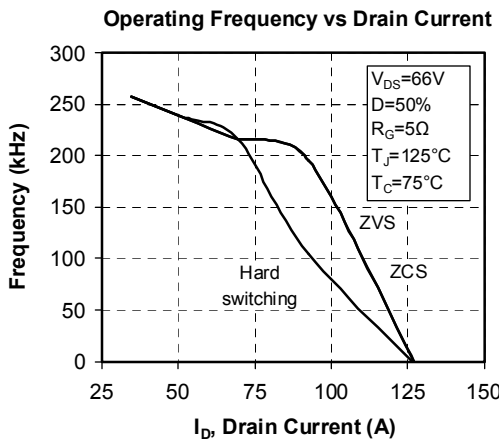
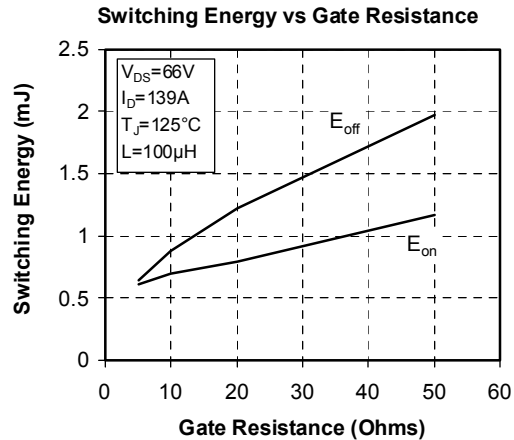
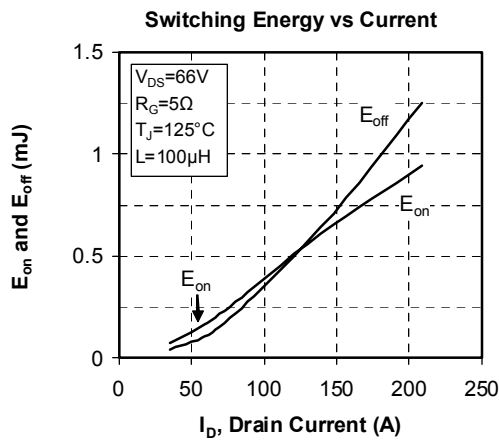
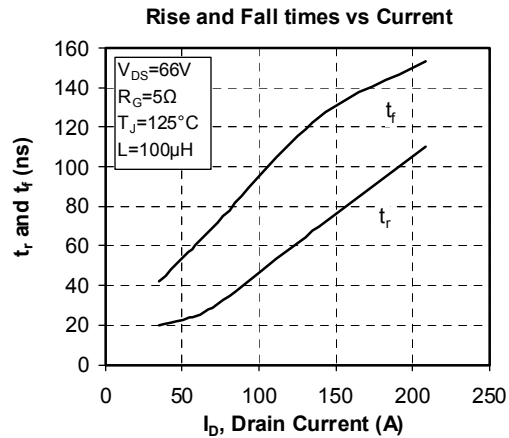
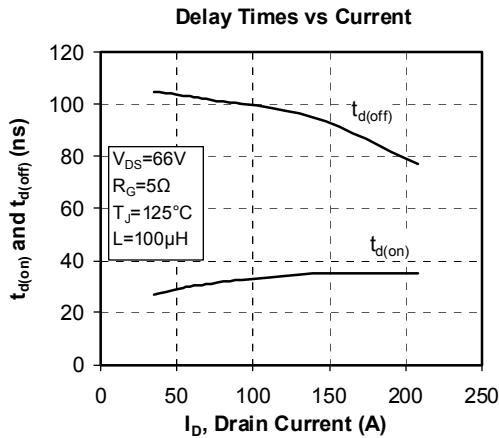



Microsemi reserves the right to change, without notice, the specifications and information contained herein

Microsemi's products are covered by one or more of U.S. patents 4,895,810 5,045,903 5,089,434 5,182,234 5,019,522 5,262,336 6,503,786 5,256,583 4,748,103 5,283,202 5,231,474 5,434,095 5,528,058 and foreign patents. U.S. and Foreign patents pending. All Rights Reserved.